

Heavy Construction

Sections

20.1 Large Buildings

20.2 Roadway Projects

20.3 Other Structures

What You'll Learn

- **Compare** the construction of large buildings to the construction of houses.
- **Describe** basic methods used in building skyscrapers.
- **Explain** why asphalt and concrete are preferred materials for roadways.
- **Identify** the ways in which bridges are supported.
- **Discuss** methods used to build tunnels.
- **List** the three main parts of a dam.
- **Tell** the purpose of a monument.
- **Explain** how construction in space is different from that on Earth.

Explore the Photo



For Art's Sake The Guggenheim Museum in Bilbao, Spain, was designed by American architect Frank Gehry. It is a remarkable feat of engineering. Complex computer-simulation programs helped make construction possible. *What kind of construction project is the Guggenheim Museum: residential, commercial, or civil?*



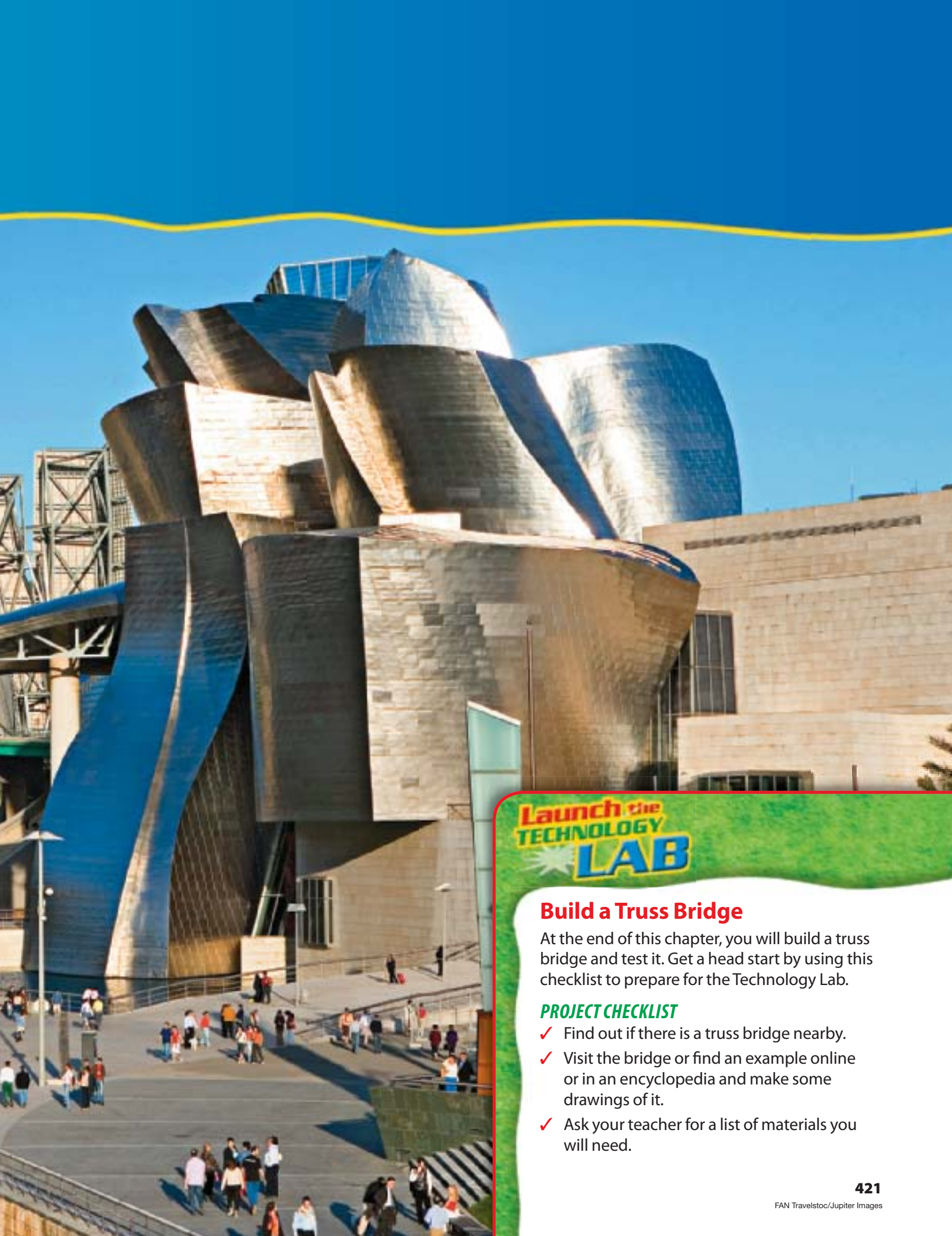

Launch the TECHNOLOGY LAB

Build a Truss Bridge

At the end of this chapter, you will build a truss bridge and test it. Get a head start by using this checklist to prepare for the Technology Lab.

PROJECT CHECKLIST

- ✓ Find out if there is a truss bridge nearby.
- ✓ Visit the bridge or find an example online or in an encyclopedia and make some drawings of it.
- ✓ Ask your teacher for a list of materials you will need.

Large Buildings

Reading Guide

Before You Read

Preview How does safety affect the construction of large buildings?

Content Vocabulary

- excavation
- pile
- pier
- crane

Academic Vocabulary

You will see these words in your reading and on your tests. Find their meanings at the back of this book.

- integral
- control

Graphic Organizer

Draw the section diagram. Use it to organize and write down information as you read.

Safety Issues for Tall Buildings

1. _____
2. _____
3. _____



Go to glencoe.com to this book's OLC for a downloadable graphic organizer and more.

TECHNOLOGY STANDARDS

- STL 3** Relationships & Connections
- STL 11** Design Process
- STL 12** Use & Maintenance
- STL 20** Construction Technologies

ACADEMIC STANDARDS

Science

NSES Content Standard F Science and technology in society

English Language Arts

NCTE 1 Read texts to acquire new information.

STL *National Standards for Technological Literacy*

NCTM *National Council of Teachers of Mathematics*

NCTE *National Council of Teachers of English*

NSES *National Science Education Standards*

NCSS *National Council for the Social Studies*

Working with Heavy Construction

What are some examples of heavy construction projects?

Structures built with heavy construction methods include skyscrapers, dams, tunnels, monuments, and bridges, which may be the most attractive structures built by modern people. Because most of these structures will be a part of the daily lives of numerous people, safety is **integral** to their design.

Heavy construction requires many workers with different skills. Sometimes thousands of people work on a single project. The designs for these massive projects come from many qualified engineers and architects who specialize in specific areas of technology. Specialization can drive technological improvements.

As You Read

Connect How is the construction of large buildings similar to the construction of houses?



 **The Burj of Greatness** Located in the United Arab Emirates, the Burj Dubai in Dubai may be the tallest building in the world. *What do you think “Burj” means?*

Skyscrapers

What is the tallest skyscraper in the United States?

Some large buildings are spread out over a great deal of land but are not very tall. They may be built where land is inexpensive or set aside for public use. Other large buildings, called “skyscrapers,” are very tall, but they do not cover a lot of land area. They are usually built in large cities where land is scarce and expensive.

Skyscrapers in the United States

Of the five tallest skyscrapers in the United States, Chicago has three. They include the Sears Tower at 1,454 feet, which is the tallest in America, the Amoco Building at 1,136 feet, and the John Hancock Center at 1,127 feet. New York City has the other two tallest skyscrapers. They are the Empire State Building at 1,250 feet and the Chrysler Building at 1,046 feet.

New York’s Manhattan Island is mostly rock. That provides a strong foundation support. This is one reason why so many other skyscrapers are located there. Manhattan’s 21-story Fuller Building, also known as the *Flatiron Building*, because its shape resembles a clothes iron, is the oldest skyscraper in the world that is still standing. It was built in 1902.

Imagine This...

Malls vs. Stand-Alone Stores?

Imagine a world without shopping malls. Today shoppers and store designers seem to prefer smaller, more open designs to large enclosed malls. Some stores are avoiding malls completely, preferring their own space. Others do their business via the Internet. *Why might businesses build their own stores?*

 Go to glencoe.com to this book’s OLC for answers and to learn more about the future of shopping.

The World's Tallest Building

The world's tallest building is called the Burj Dubai in the United Arab Emirates. But taller projects are already underway. The first skyscrapers were built because there was not enough open land in large cities. Why are they being built today?

Top This Cities take pride in skyscrapers. They bring visitors from around the world; they inspire people to dream of even taller structures. But how tall is too tall? Some believe that the contest to build the world's tallest building is a waste of resources.

English Language Arts/Writing

No Contest Competition is essential in sports. Players practice hard because they want to win. But at other times, success is the result of cooperation.

1. Discuss competition in a small group. Is it always good? What is good about it? What is bad?
2. Choose one person to take notes. Choose someone else to share your thoughts with the rest of the class.

Foundations

The foundation of a skyscraper must support a huge load. A deep **excavation** is dug, and **piles** made of concrete or steel are driven deep into the soil until they hit solid rock. Rock gives the building the proper support. Foundation walls are built, and extra support is added in the form of strong **piers**, or columns, made of reinforced concrete.

Frameworks

The inner framework of a skyscraper is usually made of steel. Workers build it floor by floor. As each floor is completed, large **cranes** lift the steel parts to the next floor level. Workers weld, bolt, or rivet the parts in place. Then the curtain walls are lifted into position and attached. These curtain walls merely hang on the structure and provide little support.

Safety

It is not unusual for people to be concerned about their safety in tall buildings. Modern construction procedures, building codes, and strict rules cover fire protection and ways of escape. Tall buildings have restrictions and **controls** about the use of fire-resistant construction materials. Even lightning conductor systems are built into modern tall buildings. All skyscrapers must sustain strong winds without swaying. In areas around the world that have earthquakes or violent storms, builders use special supports and designs to withstand movement.



Summarize How are skyscrapers built?

Other Large Buildings

How is your school built differently than a skyscraper?

Some buildings spread out over large areas of ground. In the suburbs more land may be available and may be less expensive than in the city. Buildings constructed on these suburban sites might be supermarkets, shopping malls, restaurants, office buildings, and schools.

Like skyscrapers, these structures often have steel frames and many concrete parts, unlike residential buildings. Your school may be built in this way.

However, the shape and appearance of these large buildings are usually quite different. Your school, for example, would probably have different outer walls than walls for a grocery store or a place for religious worship.

Builders usually cannot use column-and-beam framing for very wide buildings, such as auditoriums. Instead, they may use built-up girders to support large areas. They might also use trusses and arches for support.



Green Paint

Many common house paints contain lead or other toxic additives. These chemicals are added to kill mildew. However, these chemicals are also harmful to you, your family, and your pets. If you pour them down the drain, they may contaminate the water supply.

Try This Find out the brand names of non-toxic paint and stain removers, as well as cleaning agents.

section

20.1

assessment

After You Read

Self-Check

1. Name one of the tallest skyscrapers constructed in the United States, and also name the city in which it can be found.
2. Compare the foundation of a skyscraper to the foundation of a house.
3. Describe how it is possible for skyscrapers to have walls of glass.

Think

4. Which category or categories of buildings do skyscrapers belong to: residential, commercial/industrial, or public? Explain your answer.

Practice Academic Skills



Social Studies

5. Research the world's tallest skyscrapers at the library or on the Internet. Draw scaled representations of the top five skyscrapers. Use a scale of 1 inch = 100 feet. Label your drawings, including the name of the skyscraper, its height, the year it was built, and the city and country where it can be found.



Mathematics

6. The Empire State Building is 1,250 feet tall. The Chrysler Building is 1,046 feet tall. By what percentage would the Chrysler Building need to be raised to equal the height of the Empire State Building?



Math Concept Percents To determine a percentage divide the part by the whole.

1. Find the number of feet difference between the two buildings by subtracting.
2. Divide the number of feet difference by the total height of the Chrysler Building.



For help, go to glencoe.com to this book's OLC and find the Math Handbook.

Roadway Projects

Reading Guide

Before You Read

Connect What are some typical roadway projects?

Content Vocabulary

- subgrade
- abutment
- span
- suspension bridge
- cable-stayed bridge
- truss bridge
- cantilever bridge
- beam bridge
- shield

Academic Vocabulary

- allocate
- consist

Graphic Organizer

Draw the section diagram. Use it to organize and write down information as you read.

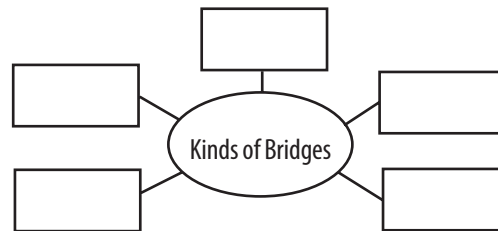

Go to glencoe.com to this book's OLC for a downloadable graphic organizer and more.

TECHNOLOGY STANDARDS

- STL 11** Design Process
- STL 12** Use & Maintenance
- STL 17** Information & Communication Technologies

ACADEMIC STANDARDS

Science

- NSES Content Standard E** Understandings about science and technology
- NSES Content Standard F** Science and technology in society

- STL** *National Standards for Technological Literacy*
- NCTM** *National Council of Teachers of Mathematics*
- NCTE** *National Council of Teachers of English*
- NSES** *National Science Education Standards*
- NCSS** *National Council for the Social Studies*

Roads and Highways

What is below the surface of a highway?

Did you know that roadway projects include streets, highways, bridges, and tunnels? Bridges allow highways or railways to cross rivers and valleys. Tunnels allow roads or railways to run *through* obstacles, such as mountains, rather than go over or around them.

As You Read

Explain Why are bridges and tunnels also considered roadway projects?

Roadways in the United States

The United States has millions of miles of roadways. Our interstate highway system covers more than 47,000 miles in length. Federal, state, and local governments **allocate** billions of dollars every year to maintain and construct roadways.

Road Construction

All paved roads are made in three layers. See Figure 20.1. The **subgrade** is the natural soil along the roadway. If it is not level or firm enough, heavy machines scrape and pack the soil. Next comes the base. A common base is sand or gravel. It provides support and keeps water from collecting underneath, which could freeze and break the pavement. Finally, the surface material is added. The surface is smooth and higher at the middle to drain off water.

Concrete

The surface material chosen depends on the type of traffic that will use the road. Highways, which are main roads, are usually surfaced with asphalt or concrete. Asphalt is a brownish-black, flexible material made from crude oil and other substances. Concrete is often preferred because it is easy to mix, does not have to be heated like asphalt, and dries to a hard, durable surface. Concrete can be strengthened with steel bars or steel mesh placed into it when it is wet. That is why it is used where the heaviest traffic is expected. Airport runways and interstate highways are surfaced with strengthened concrete that is about ten inches thick.

Asphalt

Asphalt is used for less important roads. It is also used to repair worn or damaged concrete roads. Asphalt is flexible and sticks better to old concrete than fresh concrete sticks to it.

Figure 20.1 Paved Roads

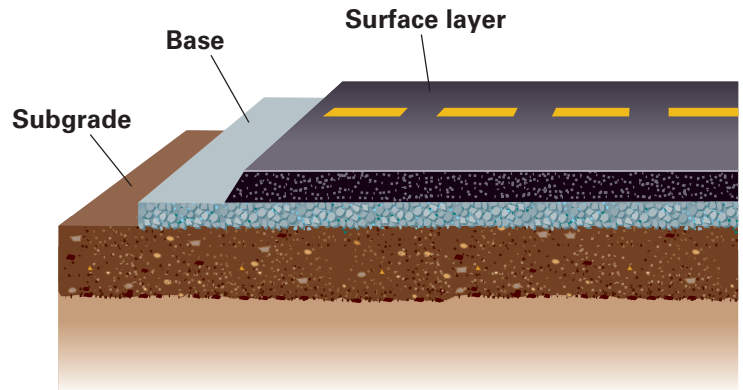

Hit the Road You have probably seen highways being constructed in your area. *Highway surface layers have to be thicker than on the roads in residential neighborhoods. Why?*

Reading Check

Identify Why are asphalt and concrete the preferred materials for making roadways?



The Golden Gate The Golden Gate Bridge in San Francisco, California, is one of the most famous bridges in the world. It was built in 1937. *What kinds of obstacles do bridges help people to cross?*

Figure 20.2 Bridges

Peter Mackinnon/Index Stock

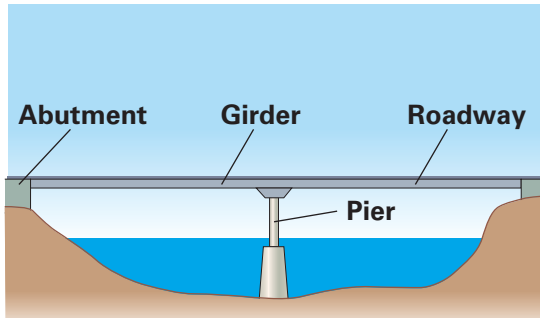

GIRDER BRIDGE

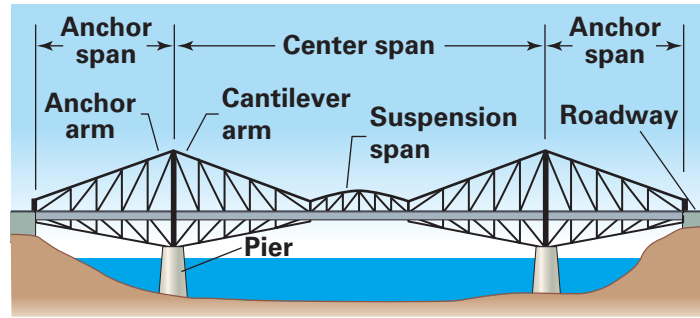

CANTILEVER BRIDGE

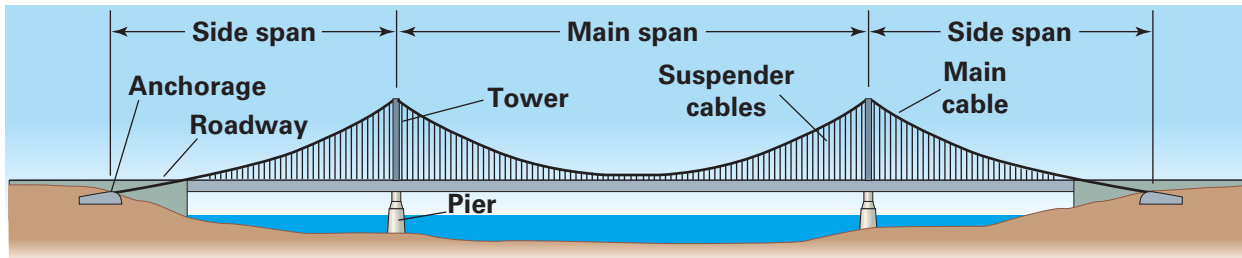

SUSPENSION BRIDGE

Types of Bridges

Bridges can be constructed in several ways. Which type of bridge might be the most expensive to construct?

Bridging the Gap

The Gateshead Millennium Pedestrian Bridge crosses the River Tyne in northeast England. It rotates to allow ships to pass. Do you think its designers thought appearance was important?



Bridges

What are the different kinds of bridges?

The roadway approach to a bridge is an important part of its design. At the ends of a bridge where it meets the land, **abutments** support both the bridge and the earth. If the bridge is long, piers may support the roadway between the abutments.

The distance between supports is called a **span**. (Sometimes the entire length of a bridge is also the span.) If the earth beneath the bridge is not stable, piles may also be used.

Suspension Bridges

The Golden Gate Bridge in San Francisco is stunning example of a suspension bridge. **Suspension bridge** roadways hang from large cables and cross wide spans. When it opened in 1937, the Golden Gate Bridge had the world's largest span at 4,200 feet, and the highest supporting towers at 746 feet.

Another type of suspension bridge is known as the **cable-stayed bridge**. Inclined cables, called "stays," connect the roadway to tall support towers. Cable-stayed bridges are cheaper and easier to construct.

Truss and Cantilever Bridges

A **truss bridge** is a bridge held together with steel beams. Beams are fastened together in the shape of triangles. The Eads Bridge in St. Louis, Missouri, is a **cantilever bridge** strengthened with trusses. A cantilever is a self-supporting beam fastened to the ground at one end. Two cantilevers meet in the middle to make the bridge. See Figure 20.2. This strong design resists high winds.

Beam Bridges

A **beam bridge** has a simple structure. The roadway rests on girders laid across the span. Beam bridges are frequently supported by piers partway along the span. Many interstate highway bridges use this design.



Summarize What are some of the ways bridges are supported?

Tunnels

How are tunnels made?

Bridges go over natural barriers, but tunnels go under or through them. Tunnels are constructed through mountains and under water. Modern tunneling methods **consist** of blasting with explosives and drilling with huge machines.



Patricia Billings

Inventor of Geobond

Patricia Billings was a trained artist. She used plaster of Paris for sculpture. But she also wanted a material that would be more resistant to breaking. Billings discovered that mixing a special cement additive with gypsum and concrete made an almost unbreakable plaster.

A scientist friend of Billings found that her new substance was resistant to heat. She went back into her basement lab and eventually created Geobond, a material that is virtually indestructible. In tests by the U.S. Air Force, Geobond held up under temperatures over 6,500 degrees Fahrenheit.

Safer Sculpting Billings created Geobond for her artistic works. However, the non-toxic material has now replaced cancer-causing asbestos, and is used to build aircraft, bridges, and other structures. Billings was awarded a U.S. patent for Geobond in 1997.

English Language Arts/Writing Research a few common items that are made with Geobond and write a short essay about them.



Go to glencoe.com to this book's OLC to learn about young innovators in technology.



The Bridges of New York City New York City includes several islands. Eleven major bridges help people get from place to place. Six of the bridges were designed by Othmar Ammann (1879–1965).

Apply Using a large map of New York City, identify its bridges and the regions they connect. Use other references to identify the bridge designs used. Can you find out which ones Ammann designed?

A large metal tube called a **shield** fits inside the tunnel as it is drilled. For immersed tunnels, pre-built sections are sunk into an excavation. Then workers connect the sections together.



Identify What is a shield?

Tunnels in the United States

At 1.7 miles, the Eisenhower Memorial Tunnel in Colorado is the longest highway tunnel in the United States. It is at an altitude of 11,000 feet and is among the highest tunnels of its type.

The Fort McHenry Tunnel in Baltimore is an immersed tunnel and was not built like others. Workers first dug an undersea trench to accommodate sealed twin-tube steel and concrete sections. They floated sections over the trench and pumped in concrete to make each section settle to the bottom. The tunnel has 32 concrete tube sections and runs 1½ miles long.

The Chunnel

The most expensive private construction project in history is the 32-mile-long tunnel under the English Channel between England and France. It was a joint venture between British and French companies and cost more than \$13 billion.

The project started in 1986, and service began in 1994. The English Channel Tunnel, or “Chunnel,” has 23.6 miles of its length underwater and is the largest undersea tunnel ever built. Its depth varies from 90 to 480 feet below the bottom of the seabed.

section 20.2 assessment



Self-Check

1. Explain why roadway surfaces are higher in the middle.
2. Compare a suspension bridge to a truss bridge.
3. Name the device used to prevent tunnel walls from collapsing after they are dug.

Think

4. Concrete highways are poured in sections with strips of tar between them. Explain the tar strips and why the concrete sections are not joined together.

Practice Academic Skills



English Language Arts/Writing

5. Do an Internet search for Web sites featuring famous roads, bridges, or tunnels. Some possibilities include

the Silk Road or the Hoosac Tunnel. Make a poster-board display with drawings and descriptions.



Mathematics

6. A ¾ inch drill was used to bore a hole through a 3-inch piece of wood. What volume of wood was removed?



Volume Volume is a measure of the space inside a three-dimensional shape.

1. A drill cuts out a cylinder when it is bored through a board with parallel sides.
2. The volume of a cylinder is found by using the formula $V = \pi r^2 h$ where $\pi = 3.14$, r is the radius, and h is the height.



For help, go to glencoe.com to this book's OLC and find the Math Handbook.

Other Structures

Reading Guide

Before You Read

Preview What other structures are built using heavy construction?

Content Vocabulary

- embankment
- outlet works
- spillway

Academic Vocabulary

- benefit
- unique

Graphic Organizer

Draw the section diagram. Use it to organize and write down information as you read.

Main Parts of a Dam

1. Embankment	2. _____	3. _____



Go to glencoe.com to this book's OLC for a downloadable graphic organizer and more.

TECHNOLOGY STANDARDS

- STL 3** Cultural, Social, Economic & Political Effects
- STL 5** Environmental Effects
- STL 6** Role of Society

ACADEMIC STANDARDS

Social Studies

NCSS Content Standard 8 Science, technology, and society

Science

NSES Content Standard F Science and technology in society

- STL** *National Standards for Technological Literacy*
- NCTM** *National Council of Teachers of Mathematics*
- NCTE** *National Council of Teachers of English*
- NSES** *National Science Education Standards*
- NCSS** *National Council for the Social Studies*

Dams

What is the purpose of a dam?

Heavy construction methods are used to build many other structures, such as dams. A dam is built across a river to block the flow of water. It is usually done for one of three reasons: 1) to provide a water supply for nearby communities and farms; 2) to provide flood control; or 3) to provide electrical power.

Most dams have three main parts: the embankment, the outlet works, and the spillway. The **embankment** is the large section that blocks the flow of water. The **outlet works** contains gates that allow a certain amount of water to flow through the dam.

As You Read

Connect How is construction in space different from construction on Earth?

Preventing Disaster

Following Hurricane Katrina, 300 top scientists and engineers developed a threat-assessment model that measures risks to infrastructure (public systems such as transportation, water, and power). Although the tool was developed for New Orleans, it may be used for other areas. This includes California, where an earthquake or flood could devastate the 2,600-mile long levee system that runs from San Francisco Bay to Sacramento.

Critical Thinking *What do you think is the meaning of "threat assessment" and why might it be necessary?*



Go to glencoe.com to this book's OLC to read more about this news.



Trade-Offs The Three Gorges Dam in Hubei province, China, is designed to provide electrical power for nine provinces and at least two cities. *What are some of the dam's negative impacts?*



Reading Check

Identify What are three main parts of a dam?



When too much water builds up behind the dam, the **spillway** allows the excess to flow around or through it and prevents the dam from breaking.

Hydroelectric dams have a power station. As water flows through the outlet works, it turns the blades of a turbine, which turns a generator, and makes electricity.

Dams in the United States

The construction of a dam usually takes many years. The Hoover Dam was opened in 1936 after about eight years of work. The project was too large for any one company, so six companies banded together to build the dam. There are numerous smaller concrete and earth dams in the United States. An earth dam is made of carefully selected soil that is hauled to the site. Layer upon layer of the soil is compacted with heavy rollers to form a watertight mass.

The Three Gorges Dam

Dams have many **benefits**, but they also impact the environment. Wildlife habitats are often lost, and there are many other trade-offs. The gigantic Three Gorges Dam in China is an example. It is the largest dam in the world. It controls severe flooding and produces as much electricity as 15 large power plants. At the same time, the dam caused the loss of more than 1,500 cities, towns, and villages, as well as uncounted wildlife habitats. The river valley is now under almost 200 feet of water.

Monuments

What is the purpose of a monument?

Monuments appeal to the human spirit. They are designed to honor the past and look to the future. The Statue of Liberty, the St. Louis Gateway Arch, and other grand monuments often inspire feelings of reverence and pride.

The Lincoln Memorial in Washington, D.C., the Eiffel Tower in Paris, France, and the Taj Mahal in Agra, India, are also examples of monuments. Some are so huge and **unique** that they required more careful design and construction than most traditional structures.

The Statue of Liberty

The Statue of Liberty that greets all ships entering New York City's harbor was a gift from France in 1886. It is meant to celebrate the personal freedoms that Americans enjoy. Its internal structure of iron beams resembles the metal cage of a skyscraper. See **Figure 20.3**. The framework is covered with molded copper sheets. As the copper oxidizes, the statue turns green in color.

The St. Louis Gateway Arch

The St. Louis Gateway Arch is in the middle of a national park on the banks of the Mississippi River in St. Louis, Missouri. It was built in memory of the Louisiana Purchase of 1803 and the westward expansion that followed. The arch is constructed of stainless steel, and its foundation extends 60 feet into the ground.

The arch was built starting from both ends at the same time. The two halves were connected at the top in 1965 after four years of construction. The Arch is 630 feet tall, which makes it the tallest monument in the United States.



Reading Check

Explain Why do people build monuments?

The International Space Station

How does construction in space differ from construction on Earth?

The United States, Russia, and other nations are building the International Space Station (ISS) that orbits around the earth. The station is permanently occupied by rotating international crews.



Supporting Liberty The Statue of Liberty is supported by a strong interior metal frame. *Which nation gave the Statue of Liberty to the United States as a gift?*

Figure 20.3

The Statue of Liberty





 **The ISS** The International Space Station orbits the earth every 90 minutes. *What does the International Space Station use as a source of power?*

Earth in American space shuttles or Russian spacecraft. All maintenance is also done in space.

The framework of the ISS is a series of trusses. Living quarters and other modules are attached at various points. As the astronauts and cosmonauts work, their tools and equipment must be tied down to prevent them from drifting away.

The ISS has huge solar collectors that draw energy from the sun and recharge its electrical batteries. The collectors extend about 350 feet, which is longer than a football field.

The ISS serves primarily as a laboratory where researchers can do experiments. They learn about the effects of very low gravity on materials and processes. They are also learning about what people need to live and work in space.

Construction of the ISS

Since construction began in 1998, all assembly of the station has taken place in space. Modules (sections), materials, and equipment are brought up from

section 20.3 assessment

After You Read **Self-Check**

1. List three reasons for constructing a dam.
2. Name the material used to construct the St. Louis Gateway Arch.
3. Identify the type of energy used to power the International Space Station.

Think

4. Hydroelectric dams create less pollution than many other power sources, yet they are used to produce only about five percent of America's electrical power. Why do you think this is so? Explain your answer.

Practice Academic Skills

English Language Arts/Writing

5. Some monuments inspire feelings of patriotism; others were built to commemorate great leaders,

thinkers, or artists. Imagine that your community has constructed a new monument. You have been asked to write a dedication. Your dedication will be engraved in the monument in stone. Write a two-paragraph dedication for the monument that explains why it was built and what it stands for.

Social Studies

6. The English Channel tunnel, or "Chunnel," is 32 miles long and runs from England to France, underneath the English Channel. In some places, it is 480 feet under the water. The safety requirements, both in its construction and operation, are unique. Research some of the Chunnel's safety requirements. Summarize your findings in two or three paragraphs.

Exploring Careers ⁱⁿ Technology

John Chan

ARCHITECT

Q: *What do you do?*

A: I design buildings for an architectural firm. The projects I work on range from the really small ones to big ones, like schools, subway stations, and university buildings. However, no matter how big or small, each structure is designed for the experience and pleasure of the people who use them.

Q: *What kind of training and education did you need?*

A: I have always liked to draw and make things. After high school, I applied to an architecture school at a university. I also visited a lot of buildings. I looked at them, studied them, and sketched them.

Q: *What do you like most about your job?*

A: I enjoy making something and putting it in this world for others to enjoy. It also gives me great pleasure to collaborate with other people. When I visit a construction site and see something that I drew take physical form, I feel a sense of happiness that is hard to compare!

Q: *How did you get interested in your job?*

A: When I graduated from architecture school, I wanted to work in an office that really explored creative solutions for buildings in this world. I set out looking for my dream job, and I found something very close to it!



English Language Arts/Writing

Propose a Building Describe a building complex you would like to construct. It can be anything from retail to entertainment to housing.

1. Using a word-processing program, write a description of the buildings, including their placement, materials, style, and other details.
2. On paper, draw the buildings from various angles.
3. Create a catalogue of the buildings and present it to your class.



Go to glencoe.com to this book's OLC to learn more about this career.

Real-World Skills

Speaking, listening, problem-solving

Academics and Education

Physics, mathematics, structural engineering, English language arts

Career Outlook

Growth as fast as average for the next ten years

Source: *Occupational Outlook Handbook*

Chapter Summary

Section 20.1 Major projects like skyscrapers are heavy construction projects. The word *skyscraper* has come to mean a tall building with an interior support frame. Skyscraper safety is an important concern. Building codes and other forms of legislation lay down strict rules for modern construction.

Section 20.2 All paved roads are made in three layers. The top layer is called the “surface.” Many bridges are strengthened with trusses. A truss is made of steel beams fastened together in the shape of many triangles. A metal tube called a “shield” fits inside a tunnel as it is constructed.

Section 20.3 Dams have three main parts: the embankment, the outlet works, and the spillway. Monuments are large structures that appeal to the human spirit. The International Space Station orbits the earth. Its framework is a series of trusses.

Review Content Vocabulary and Academic Vocabulary

- On a sheet of paper, use each of these terms and words in a written sentence.

Content Vocabulary

- excavation
- pile
- pier
- crane
- subgrade
- abutment
- span
- suspension bridge

- cable-stayed bridge
- truss bridge
- cantilever bridge
- beam bridge
- shield
- embankment
- outlet works
- spillway

Academic Vocabulary

- integral
- control
- allocate
- consist
- benefit
- unique

Review Key Concepts

- Compare** the construction of large buildings to building a house.
- Summarize** the process of building a skyscraper.
- Discuss** why construction differs in other large buildings.
- Describe** the use of asphalt and concrete in road construction.
- List** ways in which bridges are supported.
- Identify** methods used to build tunnels.
- Name** a dam’s three main parts.
- Discuss** monuments and why people build them.
- Compare** construction in space to construction on Earth.



Real-World Skills

- 11. Construction Safety** Research safety concerns at a high-rise construction site. Write a summary of what you find. Discuss the safety measures and the equipment used.

STEM Technology Skill

- 12. Monuments** Many monuments in this country were built a long time ago. The technology used to build them differs greatly from technology today.
- Use the Internet to research U.S. monuments.
 - Summarize what you find. Compare the technology used in the past to today's technology.



Situation You have been asked to design a fire watch tower for a local forest. The tower will be on high ground and must comfortably accommodate two live-in rangers, permit 360° viewing, and be structurally sound. The observation deck must be between 36' and 37' above the ground.

Activity Working with your team, develop preliminary sketches. Agree on a design and construct a rough model. Test it for structural stability (wind tunnel) and strength (compression). Make any necessary changes. Finally, construct the final model to scale with 1/4 inch = 1 foot. Present your design to your class.

Evaluation Your project will be evaluated by these criteria:

- Functional—360° viewing
- Structurally sound—withstands tests
- Living environment—comfortable, attractive



Go to glencoe.com to this book's OLC for information about TSA events.

Academic Skills



Social Studies

- 13.** Do some research at the library on different bridges around the world. Write a few paragraphs describing some of the bridges you research. Include a discussion of types and their history.



Mathematics

- 14.** Susan walks her two dogs everyday. The path she takes is 2.3 miles long. If she completes her walk in 45 minutes, what is her average speed in miles per hour?



Average Speed

When calculating average speed, pay attention to the units. To convert minutes to the decimal equivalent of hours, divide the minutes by 60. There are 60 minutes in 1 hour.

Standardized Test Practice

Directions Choose the letter of the best answer. Write the letter on a separate piece of paper.

- How many minutes are in 4 days?
A 2,870 **C** 5,760
B 7,375 **D** 3,600
- The section of a dam with gates that allow water to flow through is called the outlet works.

T

F

Test-Taking Tip Getting a good night's sleep before the test can reduce test anxiety.

Build a Truss Bridge

Much of the strength of a bridge comes from its design. Truss bridges were developed in the 1500s. The parts of a truss are arranged in the form of many triangles.

Tools and Materials

- ✓ Six 36-inch-long pieces of $\frac{3}{16}$ -inch balsa strips
- ✓ Quick-drying adhesive
- ✓ Pencil
- ✓ Paper
- ✓ Ruler
- ✓ Cutting blade
- ✓ 2- to 3-gallon plastic bucket with handle
- ✓ Sand
- ✓ Nylon cord
- ✓ Small piece of hardwood
- ✓ Scale
- ✓ Safety goggles and long-sleeved shirt

Set Your Goal

For this activity, you will build a truss bridge and test it.

Know the Criteria and Constraints

In this lab, you will:

1. Construct a bridge that measures 18 inches long, 4 to 6 inches tall, and 4 to 6 inches wide. It must be able to accommodate the piece of hardwood used in the test.
2. Use balsa wood to construct your bridge. Do not use any metal.
3. Make all joints flush. No joints may overlap.

Design Your Project

Follow these steps to complete this lab.

1. Research truss bridge designs.
2. Make a full-scale drawing of a bridge that is exactly 18 inches long, between 4 and 6 inches tall, and about 4 to 6 inches wide.
3. Construct the bridge using $\frac{3}{16}$ -inch balsa wood strips. To improve stiffness of the main horizontal supports, glue two strips together. See illustration. No overlapping joints are allowed.

SAFETY

Reminder

In this lab, you will be using cutting tools and must wear safety glasses. Be sure to always follow appropriate safety procedures and rules so you and your classmates do not get hurt.

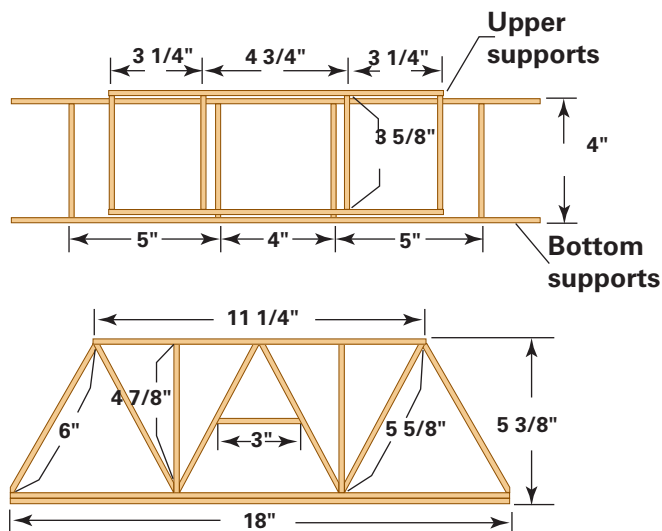

4. Your design must be able to fit the piece of hardwood used to test the bridge. Leave an opening that measures at least $1\frac{1}{2} \times \frac{1}{2}$ inches across the middle of your bridge. This is where the hardwood and bucket will fit.
5. After the adhesive has dried, record the weight of your bridge.
6. Arrange two tables so they are 16 inches apart. Place your bridge across the gap between the tables. Put the hardwood on the bridge and tie the bucket to it with nylon cord. The bucket's bottom should be about 4 to 6 inches above the floor. See illustration.
7. Perform the experiment:
 - Put on your safety glasses and a long-sleeved shirt.
 - If possible, make a video to show how long your bridge lasts.
 - Slowly pour sand into the bucket until the bridge breaks. It may fail quickly and could scatter broken wood and sand.
 - Make sure the bucket of sand does not tip over when it drops.
 - Weigh the bucket to see how much load your bridge carried.
 - Record the results.

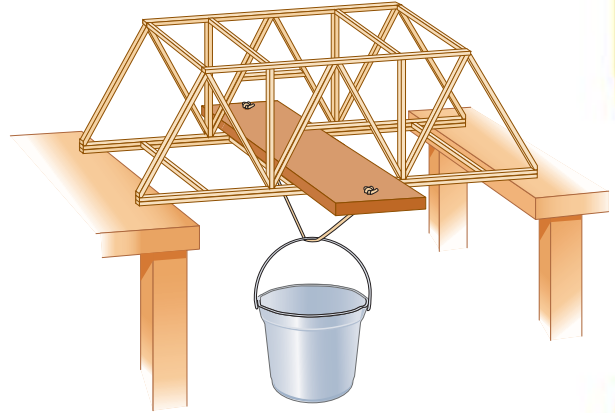

Evaluate Your Results

After you complete the lab, answer these questions on a separate piece of paper.

1. How much weight did your bridge carry in comparison to its own weight?
2. Where did your bridge begin to fail: at the center, the edges, or the top? How could you change it so that it would carry a heavier load?

Academic Skills Required to Complete Lab				
Tasks	English Language Arts	Math	Science	Social Studies
Research truss bridge design.	✓		✓	✓
Make full-scale drawing of your bridge.		✓	✓	
Construct bridge with balsa wood.		✓	✓	
Conduct experiment to see how much weight the bridge will hold.		✓	✓	
Calculate ratio of weight of bridge to weight of load.		✓		

Technology Time Machine

Construction by Design

Play the Game This time machine will travel to the past to show you that all great achievements in design and construction require careful planning and engineering. To operate the time machine, you must know the secret code word. To discover the code, read the clues, and then answer the questions.

Clue 1

2500 B.C.E. Egypt's three great Pyramids of Giza were built about 4,500 years ago. The largest pyramid contains 2,300,000 stone blocks, each averaging 2½ tons. The mystery of how the heavy blocks were put in place has been studied for generations. The builders used surprisingly accurate mathematics.



Clue 2

221–206 B.C.E. Construction for the world's longest structure, the Great Wall of China, began during the Qin dynasty to keep out invaders. The wall was built by hand with earth and stones held in wood frames. During the Ming dynasty (1368–1644), the wall was given its present form. The main wall is about 1,500 miles long, and the total length is nearly 4,500 miles.



Clue 4

1931 New York City's Empire State Building was completed in 16 months. At 1,250 feet in height with 102 stories, it was the world's tallest building until the 1970s, when the now-destroyed World Trade Center was built. In 1950, it measured 1,472 feet with antennas.



Clue 3

1895 The Biltmore Estate outside Asheville, North Carolina, was inspired by the great mansions of Europe. Created for George Washington Vanderbilt III, the house features 250 rooms with 34 bedrooms, 3 kitchens, 43 bathrooms, 65 fireplaces, a bowling alley, a gym, and an indoor swimming pool.



Clue 5

1944 Construction of the U.S. Highway System was delayed until 1956, when President Dwight D. Eisenhower authorized moving the project forward for transport of the military. Interstate highways carry more than 20 percent

of all traffic, but represent only about 1 percent of the nation's roadways.



Clue 6

1954 R. Buckminster Fuller received a patent on the geodesic dome, one of the lightest, strongest, and most cost-effective structures. Domes are assembled from interlocking polygons. They enclose more space without internal supports than any other structure. A well-known geodesic dome is Epcot Center at Walt Disney World in Florida.



Clue 7

2001 The leading "green" agency built the "greenest" high-rise in the country. The 25-story Joe Serna Jr. Building in Sacramento, California, is home to the state's Environmental Protection Agency. It includes recycled-content ceiling tiles and worm-composting bins.



Crack the Code

On a piece of paper, write the answers to these questions:

1. Which president authorized the U.S. Interstate Highway System?
2. What is the tallest building in New York City?
3. What type of finished blocks were used to build the great pyramids?
4. Geodesic domes are assembled from this type of polygon.
5. Name one of the lightest and strongest structures.
6. Where is the Empire State Building located?

Now write down the first letter of each answer. Put them together to discover the secret code word!

Hint It is important to choose this prior to building a home or other structure.

unit 6 Thematic Project

Planning a Green Shelter

Construction Technology In Unit 6, you learned how construction systems for homes and shelters evolved from log houses to contemporary skyscrapers. Today the problem of global warming is affecting how we build shelters. We look for ways to reduce our use of fossil fuels. Sustainable development is influencing construction practices that reduce negative impacts on the environment.

Building Green A green building is a sustainable building. It is a structure designed, built, and operated in a way that uses and reuses energy, materials, and water efficiently.

This Project In this project, you will plan a green shelter.

Your Project

- Choose a type of shelter.
- Complete these tasks:
 1. Research one or more aspects of the design of your green shelter:
 - Materials Selection
 - Heating and Cooling
 - Appliances and Fixtures
 - Conservation and Pollution Control
 - Interior Design
 2. Draw a picture or create a 3D model.
- Write a report about your research and model.
- Create a presentation with posters or presentation software.
- Present your findings to the class.

Tools and Materials

- ✓ Computer
- ✓ Internet access
- ✓ Books and magazines about home and shelter building
- ✓ Word-processing software
- ✓ Presentation software
- ✓ Posterboard
- ✓ Colored markers

The Academic Skills You'll Use

- Communicate effectively.
- Speak clearly and concisely.
- Employ correct spelling, grammar, and usage in a written report.
- Conduct research using a variety of resources.
- Incorporate reading, writing, and speaking with viewing, representing, and listening.

English Language Arts

NCTE 4 Use written language to communicate effectively.

Science

NSES Content Standard F Science in Personal and Social Perspectives: Science and technology in society



Step 1 Choose Your Topic

You can choose any type of shelter for your project. Examples include:

- New or remodeled house
- Dog house for cold winters and hot summers
- Garden shed with an attached greenhouse
- Barn for horses with a wash rack, indoor arena, and viewing stands

Tip! Choose a shelter you would like to use!

Step 2 Do Your Research

Research different types of shelters people or animals live in around the world. Look for ideas to use. Find out about techniques builders use in green construction. Answer these questions:

- How can you reuse and recycle construction and demolition debris?
- How can you limit damage to existing trees and other plants at the building site?
- What “green” materials will you use?
- How can you maximize energy efficiency?

Tip! Ask a contractor where to find information!

Step 3 Explore Your Community

Find a local architect, builder, or general contractor who has worked on environmentally friendly buildings. Interview him or her about the positive and negative aspects of green construction.

Tip! Remember to listen attentively!



GLOBAL TECHNOLOGY

Reaching for Green

Skyscrapers are getting taller every year, but taller is not always “greener.” However, in Mumbai, India, architects designed The India Tower. It includes residences, a hotel, and offices. It might be the tallest building in the world with a certified green rating. Sustainable features include a solar chimney to generate electricity, waste-water reclamation, “daylighting” design for use of sunlight, natural ventilation, and rainwater harvesting.

Critical Thinking Why are this building’s features considered sustainable and green?



Go to glencoe.com to the book’s OLC to learn more and to find resources from **The Discovery Channel.**

Step 4 Create Your Project

Your project should include:

- 1 research report
- 1 model of your shelter
- 1 written report about your project
- 1 presentation

Project Checklist

Objectives for Your Project

Visual	✓ Make a scale drawing or 3D model.
	✓ Show the aspects of your shelter that make it environmentally friendly.
Presentation	✓ Make a presentation to your class.
	✓ Include the notes from your research.

Step 5 Evaluate Your Presentation

In your report and/or presentation, did you remember to:

- Demonstrate your research and preparation?
- Engage your audience?
- Back statements with facts and evidence?
- Use visuals effectively?
- Speak slowly and enunciate clearly?



Rubrics Go to glencoe.com to the book’s OLC for a printable evaluation form and your academic assessment form.

Hindi

<i>hello</i>	namaste
<i>goodbye</i>	achcha
<i>How are you?</i>	Ap kaise hain?
<i>thank you</i>	sukriya